

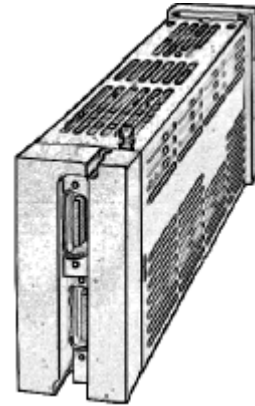

MOD 30 RetroPAK Controllers

- Replaces aging controllers in logical increments
- Combines the functionality of MOD 30 Controllers, Math Unit, SLU
- Fits same bezel & cutout
- Accepts MOD 30 termination cables
- Communicates via ICN with MOD 30, Local Control Panel and Communication Link
- High visibility display, easier to operate
- Front panel tuning
- Portable Memory Module option



“The Right Fit for Retrofit”

The MOD 30 RetroPAK provides the easiest migration path from Taylor MOD 30 instruments to the latest technology. It combines the functions of the 1700 Series Controller, Controller XL, Math Unit, and Sequence and Logic Unit (SLU) into one instrument, and offers all the features that made the Taylor MOD 30 so popular. In addition it offers a host of other powerful features and up-to-date communication strategies that make RetroPAK the logical choice for replacing aging MOD 30 controllers.

HARDWARE PLATFORM

The basis of the MOD 30 RetroPAK, the MOD 30ML, was designed as the next generation of MOD 30 instrument. It fits the same panel cutout and bezel, making it easy to replace old MOD 30's one at a time or in logical groups.

There are two termination versions available, depending on the existing MOD 30 installation. The RetroPAK style termination is designed to easily replace MOD 30 instruments connected to the 1720F Standard Termination Panel using the 1750F series cables. Simply remove the MOD 30 and its housing, install the RetroPAK controller and connect the cable. Field wiring and 24V dc power connections remain in place at the 1720F Termination Panel.

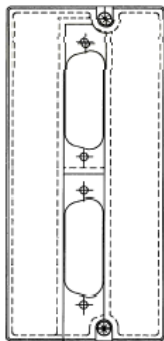
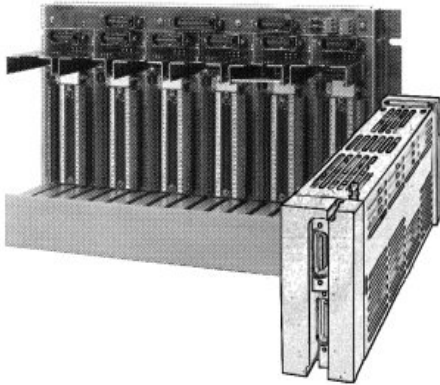

The second termination option provides a fifty-position, two-piece terminal block assembly for direct connection of field wiring at the back of the instrument. The terminal blocks can be temporarily unplugged from the controller to facilitate wiring. This version is typically used when the original MOD 30 installation consists of Unified Instruments, or when replacing two or more MOD 30 instruments with one MOD 30ML controller and eliminating the original MOD 30 termination panels. This version is available with AC or DC power and makes additional I/O and communications available for control strategies. For more information on this version, refer to S-MOD-1800R.

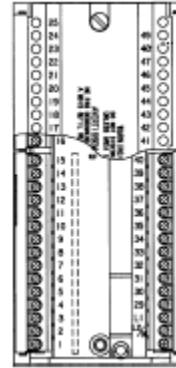

FUNCTIONALITY

The MOD 30 RetroPAK includes all the functionality of the MOD 30 series, making it suitable for replacing any MOD 30 installation. Algorithms and functions include:

- Up to six control loops, each with:
 - 18 variations of PID control
 - Adaptive tuning
 - Cascade
 - Feedforward
 - External feedback
 - MICROSCAN™ Reset
 - Bumpless mode transfer
 - Setpoint and output tracking & limiting
 - Ratio & Bias
- Signal selection
- Timers
- Math calculations with unlimited steps
- Discrete and continuous logic
- Linearization
- Configurable process alarms - unlimited
- Totalization
- Sequence control
- ICN Communications
- Comprehensive diagnostics

PROCESS I/O

The RetroPAK controller can be ordered with the same I/O complement as the MOD 30 Controller XL (1701R) for a one-to-one replacement:

- 3 analog inputs, 1-5 volts
- 2 milliamp outputs
- 2 digital inputs
- 3 digital outputs

For replacing Math Units or an SLU without expanded I/O, the Conversion style RetroPAK controller will accept up to two MOD 30 Instrument cables. If the original installation is MOD 30 Unified instruments, or the MOD 30 Standard Termination Panel is being removed from the system architecture, a standard MOD 30ML is typically used. In both cases, the controller provides two universal analog inputs and two 4-20mA outputs, and up to 11 additional I/O points can be added by choosing from any of the following plug-in modules. Each module provides one input or one output:

- Current input, with or without transmitter power supply
- 3-wire, 100 ohm RTD or 2-wire, 1000 ohm RTD input with upscale burnout detection
- Thermocouple input with upscale burnout detection (all standard thermocouple types; cold junction compensation provided)
- Volt/millivolt input
- Isolated digital input (2.5-28Vdc, 4-16Vdc, 10-32Vdc, 12-32Vac)
- Non isolated (contact sense) digital input
- Isolated digital output (5-60Vdc, 5-200Vdc, 12-140Vac, 24-280Vac)
- Non isolated digital output
- Mechanical relay output (two Form A outputs, two Form B outputs or one Form C output)

All analog I/O modules, and the solid state digital I/O modules are individually isolated channel-to-channel and channel-to-ground to provide maximum protection.

When replacing a 1710R Sequence and Logic Unit (SLU) with extended digital I/O the standard MOD 30ML controller is typically used. Up to 100 remote digital I/O points can be added using PLC-style I/O blocks on a twisted pair network. The digital expansion I/O is configured using the same engineering tool as the built-in and modular I/O. It also offers the same failsafe features as the on-board I/O.



Extended Digital I/O

For installations using the extended analog I/O with the SLU, the MODCELL Multiloop Processor provides up to 30 analog and/or digital points per module. The MODCELL can be used as an I/O extension to the RetroPAK controller using the ICN, or the sequence and logic control functions can be performed in the MODCELL itself, with operator interface being provided by the Local Control Panel or personal computer.



MODCELL Multiloop Processor

OPERATOR DISPLAY

The MOD 30 RetroPAK has a bright, highly visible vacuum fluorescent front screen which is easily viewed from a greater distance and provides even more process information than the MOD 30 instruments. In addition, operation of the RetroPAK controller is simpler and more user-friendly.

Standard Operating Screens

In normal operating mode each screen shows three bargraphs representing Process, Setpoint, and Output. Three eight-character alphanumeric lines indicate the Loop Tag; the process value in engineering units; and the numeric value of the variable indicated by the Status Indicator (typically Output and Setpoint). Three-character Status Indicators display controller Mode (Auto/Manual), Setpoint status (Local/Remote), and the variable whose value is being displayed on the bottom line of the screen. The up/down arrow keys are used for changing this value. The standard ramping method allows the operator to select the desired value without any overshoot, and unlike MOD 30, it is not necessary to hold down more than one key for fast ramping.

User-definable Alarm Screens

Active process and diagnostic alarms are indicated by the flashing red LED on the keypad, and/or flashing display and audible alarm. Like MOD 30, complete alarm information including value, alarm type (high, low, deviation etc.) and user-configured label can be viewed by pressing the Alarm key. Any number of alarms may be configured for an analog or a digital signal, and there is no fixed limit to the total number of alarms per RetroPAK controller.

Tuning and Commissioning Screens

Control loops are tuned through Tuning displays, accessed by a user-specified password from the front panel of the RetroPAK controller. Standard tuning parameters, recipe parameters, and X,Y table coordinates can be entered through the faceplate, without the need for a handheld terminal or computer, thus eliminating the MOD 30 Portable Configurator.. The controller also displays raw input values for commissioning and startup, as well as detailed diagnostic information before and during normal operation. An Event Queue of up to 1024 entries is maintained by the instrument, and can be viewed from the front panel.

Custom Displays

In addition to standard displays, application-specific screens can be configured for sequence and batch operations, discrete device operation, recipe selection, and multiple variable indication. Keys can be assigned different functions on a per-display basis through a script language. The number of screens per controller is limited only by operator preference and plant operating philosophy. It is also possible to configure hidden screens accessed through a tuning-level password. This is an ideal way of providing local operator interface to functions which previously required an operator panel or personal computer.

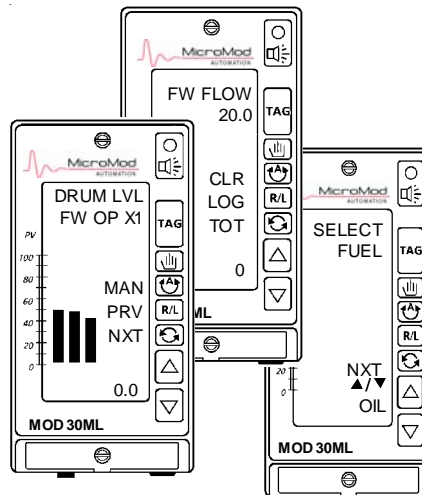
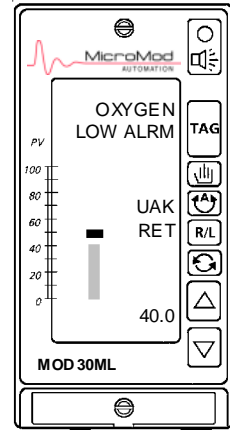
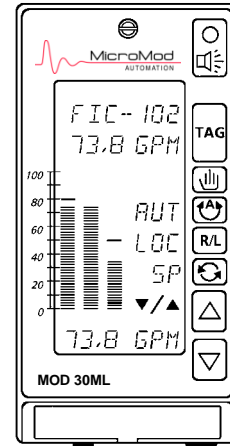

COMMUNICATIONS

The RetroPAK controller includes the Instrument Communications Network (ICN) as a standard function, for peer-to-peer communication with other RetroPAK controllers, MODCELL Multiloop Processors, the Local Control Panel (LCP), and the MOD 30 Communication Link to a personal computer. This allows replacement of one MOD 30 instrument at a time, without having to reconfigure the addresses in the remaining MOD 30 instruments, the LCP, or the personal computer software. The ICN is a token-passing ring protocol which guarantees every instrument access to the bus within a determinate amount of time (nominally 250ms). If an instrument on the bus should cease to communicate, its peers generate diagnostic alarms but continue to operate with the last good data received.

In many cases a second serial communication port can be added using a plug-in module for RS-232 Modbus, RS-485 Modbus or a second ICN network. The communication protocol for the second port is independent of the protocol selected for the built-in port.

SAFETY AND SECURITY

The RetroPAK controller includes all the features of the MOD 30 instruments for protecting process and personnel and preventing or minimizing downtime.

Portable Memory Module

The memory module for RetroPAK controllers has a larger capacity for database storage than the MOD 30 memory module, but it performs exactly the same functions. It can be used to copy configurations to other RetroPAK controllers or for backup and restore functions. When installed on an operating instrument, it is updated every 50ms with the current process parameters including PID and sequence output values and status, tuning values, sequence steps, calculation results etc. Continuous checksums insure against corruption of memory module data. In the event an instrument needs replacement, the Memory Module can be installed on the new controller for instant, as-you-were recovery of operations.

Initialization Routines

Like MOD 30, the RetroPAK controllers offer the capability to determine the controller functions on power-up, on accidental power failure, or supervisory system failure. But where MOD 30 was limited to configurable power-up mode, setpoint source, setpoint value and output value, the RetroPAK controller provides this feature on every parameter and output. In addition, warm- and cold-start options allow different settings depending on a user-specified time period before power is restored.

Signal Quality Detection

All inputs and outputs have quality detection and an associated alarm bit, allowing the controllers to change mode based on signal quality for strategies such as manual override. In addition, all internal signals can be configured for quality checking. The configured information is stored in the controller's non-volatile memory. This feature can accelerate the restart process and significantly reduce downtime.

Failsafe output settings

The user also has the option to select failsafe values, either 'previous' or a user-determined value, on all outputs should the controller I/O lose communication with the CPU. These values are independently configurable for each output, and reside in the modules. The Expansion I/O also allows failsafe settings.

Single-point isolation, Cut-wire detection

Inputs, outputs and built-in communications are individually isolated, channel-to-channel and channel-to-ground. This helps eliminate propagation of noise and spikes on signal and power lines when the controller is properly grounded. Each I/O point includes short-circuit and cut-wire detection with associated diagnostics, and a digital flag that can be used to initiate alternate control logic such as safe shutdown. Out-of-range and quality diagnostics are also associated with each point.

Output Holder Option

The RetroPAK controllers can be used with existing MOD 30 Output Holder panels. Or, the new 1750N Output Holder can be installed. This device is installed in the panel and provides visualization and manual control of the output in the event the RetroPAK controller is removed from service. Like the MOD 30 output holder, a feedback signal provides bumpless transfer when a new controller is installed.

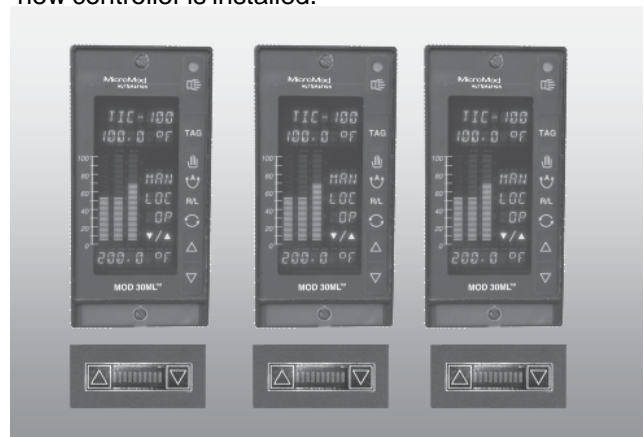

RetroPAK Controllers with 1750N Output Holders

CONFIGURATION

Basic PID loops, without math or logic, can be configured from the front panel of the RetroPAK controller. For strategies with additional control functions, the Visual Application Designer software is required.

The Visual Application Designer software provides a Windows-based environment for creating, editing, downloading, documenting and debugging controller databases. It provides automatic, on-screen documentation of the configuration, including signal source and destination. On-line, context sensitive help is available for each block and function. Standard templates for single loop control, single station cascade and other common strategies are provided in the software library.

Live debug and runtime facilities allow on-line verification of the database and process logic, and trend windows simplify loop tuning at commissioning time. There is also a set of drawing tools that can be used to construct runtime displays or place dynamic process symbols next to the algorithm blocks in the configuration for easier debugging, without using a separate HMI package.

Automatic report generation includes tabular reports containing all blocks in the system, their internal parameters, and all connections, as well as graphical reports showing the database diagram exactly as it is drawn.

STEAMPAK SERIES

For standard boiler control applications, MicroMod offers pre-engineered, pre-configured packages that perform all the functions of the MOD 30 instruments with less hardware, less engineering and less startup time. Each package is designed by our boiler experts to meet the needs of the majority of installations. One simple model number includes a preconfigured controller, detailed installation instructions specific to the application, and a clear operating guide tailored to the individual loops. Several packages also include pre-ranged field instruments.

- DRUMPAK – two and three-element drum level control packages
- TRIMPAK – dual fuel combustion control upgrade package with O2 trim for jackshaft boilers
- METERPAK – dual fuel, fully metered combustion control system with cross-limits, furnace pressure control and O2 trim in just three controllers

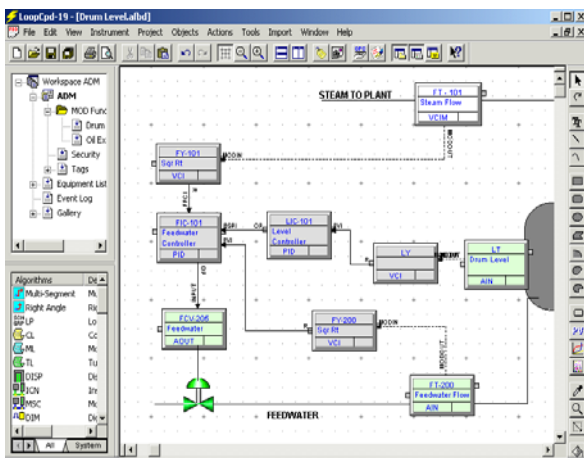

GENERAL SPECIFICATIONS

PID Loops

six single or four cascade

Execution Time

Built-in I/O: 100mSec.

Analog Module I/O: 150mSec. nominal

Digital I/O: 50mSec.

Operating Range

AC option: 85-250V rms, 50-400Hz

DC option: 20-50V dc

MOD 30 termination style: 24V dc

Fuse

2.5 Amps (ac), 4.0 Amps (dc)

Power Consumption (120V rms, 60Hz, Full load)

50W maximum

Data Retention (Non volatile RAM memory and Portable Memory Module)

Typically 10 years with instrument unpowered

Operating temperature

0 to +50°C

Storage Temperature

-40 to +75°C

Humidity

5 to 95% RH, noncondensing

Open Input Fault Detection

Controller recovery is user configurable for all inputs

Fault Output

Built-in outputs - last value or 0%

Module outputs - user defined between

0 and 100%

ICN Baud rate

31.25K Baud

Modbus Baud rate

150 to 38.4K Baud

PHYSICAL SPECIFICATIONS

Height

Bezel - 5.69" (144.5 mm)

Panel cutout - 5.47" (138.9 mm)

Width

Bezel - 2.87" (72.9 mm)

Panel Cutout - 2.69" (68.3mm)

Safety Approvals

ABB Instrumentation General Purpose

FM Approved and CSA Certified Class I, Division 2,

Groups A, B, C, D

Depth

Behind the panel - 15.75" (400 mm)

Front of panel - 1.13" (28.7 mm)

Weight

Base instrument with identity module: 4.7 lbs.

Fully module loaded: 6.0 lbs.

Mounting

Instrument mounts directly in a panel or may be

mounted in a 1705FZ Instrument Trim Bezel.

I/O PERFORMANCE SPECIFICATIONS

Built-In Universal Analog Inputs and Outputs

Analog Inputs (2)

Transmitter power	Isolated 24Vdc, one per input				
Range/Span	Configured as:	Min	Max.	Min span	Impedance
	Millivolt	-10	120	10	10MΩ min
	Volts	0	6.0	0.1	10MΩ min
	Milliamps	0	22	1.0	100Ω nominal
	Resistance	500 ohms (20 Ω min. with 3.9KΩ resistor added)			

Temperature Input Linearization

Thermocouple – per NBS 125 and IEC 584 standards
 RTD – per IEC751 and DIN43760 standards

Measuring Range Limits – Thermocouple or RTD	°F Lower	°F Upper	°C Lower	°C Upper
Type B	392	3308	200	1820
Type E	-328	1832	-200	1000
Type J	-346	1400	-210	760
Type K	-328	2501	-200	1372
Type N	32	2372	0	1300
Type R&S	32	3214	0	1768
Type T	-430	752	-257	400
RTD	-328	1562	-200	850

Note: Performance accuracy is not guaranteed below 752°F (400°C) for Type B thermocouple. RTD, 3-wire platinum, 100 ohm per DIN 43760 (IEC751), with range of 0-430 ohms (normal) or 0-55 ohms (low).

Common Mode	45Vdc
Isolation	Full galvanic isolation using transformers and opto isolators

Analog Outputs (2)

Range	0 to 22mA non-isolated with user set span (minimum 1mA)
Load	22mA at 1000 ohms maximum

Modular Inputs and Outputs - Analog Input Modules

Voltage 2001A

Range	(0-100%) ±10V dc, ±100 mV dc
Low limit	-11V, -110mV
Upper limit	+11V, +110 mV
Input Resistance	1 megohm
Noise filter	3db at 5 Hz, 3 db at 3 Hz
Resolution	16 bits
Sensitivity	0.4mV, 4uV
Accuracy	(calibrated) 0.1%
Isolation	250V rms
Max. Survivable Input	±300V dc or 250V ac (Differential)
Common mode rejection	100 db at 60 Hz minimum
Normal mode rejection	40 db at 60 Hz minimum

Current with 2-wire transmitter power 2012A

Range	4 to 20mA
Low limit	0 mA
Upper limit	27.5 mA
Input Resistance	50 ohms
Noise filter	3db at 5 Hz
Resolution	14 bits
Sensitivity	1µA
Accuracy	0.2%
Isolation	250V rms
Normal mode rejection	40 db at 60 Hz minimum

Current 2002A

Range	(0-100%) 4 to 20mA
Low limit	0 mA
Upper limit	24 MA
Input Resistance	2.5 ohm
Noise filter	3db at 5 Hz
Resolution	13 bits
Sensitivity	1.6 uA
Accuracy	0.2%
Isolation	250V rms
Max. Survivable Input	50 mA dc (Differential)

Thermocouple 2013A

Types	B,E,J,K,N,R,S,T
Range	±100 mV dc
Low limit	-110 mV
Upper limit	+110 mV
Input Resistance	10 Megohms
Noise filter	3 db at 3 Hz
Resolution	16 bits
Sensitivity	4 uV
Accuracy (calibrated)	0.1%
Isolation	250V rms
Normal mode rejection	40 db at 60 Hz typical

I/O PERFORMANCE SPECIFICATIONS

Modular Inputs and Outputs - Analog Input Modules (continued)

RTD 2009A

Input Range	Range	Low Limit	Upper Limit
2-wire	0-4000 ohms (1000 ohms nominal)	0 ohms	4200 ohms
3-wire	0-400 ohms (100 ohms nominal)	0 ohms	400 ohms
Input Resistance	100 ohms each lead		
Noise Filter	3 db at 5 Hz		
Resolution	2-wire: 0.08 ohms/count		
Accuracy (absolute)	2-wire: ± 2 ohms		
Isolation	250 V rms		
Common Mode Rejection	100 db at 60 Hz minimum		
Normal Mode Rejection	40 db at 60 Hz minimum		

Analog Output Module

Current Output	2003A
Range	(0-100%) 4 to 20 mA
Low limit	0 mA
Upper limit	25 mA
Open circuit voltage	26 Volts maximum
Isolation	250V rms
Resolution	12 bits
Sensitivity	5 μ A
Accuracy	$\pm 0.2\%$
Load Limit	0 - 800 ohms

Digital Input Modules

Isolated Digital Inputs 2004A

2004AP10...	...100A	...110A	...120A	...130A	...140A	...150A
Input voltage ranges	2.5-28Vdc	4-16Vdc	10-32Vdc 12-32Vac	35-60V ac/dc	90-140V ac/dc	180-280V ac/dc
Max Logic Low Input	1V	1V	3V	9V	45V	80V
Max Input current	30mA	45mA	25mA	6mA	11mA	6.5mA
Response time	1.5 msec	0.1 msec	5 msec	10 msec	20 msec	20 msec
Input resistance	900 ohms	300 ohms	1000 ohms dc 1500 ohms ac	10K ohms	14K ohms	43K ohms

Non isolated digital inputs 2006A

Contact sense	5V/ 0.5 mA dc typical
Logic Low Input	0 to 0.65V dc or 50K ohms minimum
Logic High Input	2.2 to 24V dc or 50 ohms maximum
Max Input current	2.5 mA dc
Response time	1 msec

Digital Output Modules

Isolated digital outputs 2005A

2005AP21...	...100A	...110A	...120A	...130A/140A
Output voltage ranges	5-60V dc	5-200V dc	12-140V ac	24-280V ac
Max Output current	1A	0.55A	1A	1A
Response time	0.75 msec	0.75 msec	1/2 cycle	1/2 cycle

Nonisolated digital outputs 2007A

Output voltage range	+5 to +24V dc
----------------------	---------------

Mechanical Relay Output 2011A

Types	Dual independent relays (NO/NO, NC/NC, NO/NC) or Form C single relay
-------	---

MOD30 RETROPAK	06	07-08	09	10	11	12	13	14	15
Base Controller	1800RZ								
Approvals									
General Purpose		10							
CE (European Community destinations only)		12							
Power Supply									
24V dc			0						
I/O Options - see Note 1									
Standard I/O only (two universal analog inputs, two current outputs)				1					
Pre-installed I/O modules (one additional analog input, 2 digital inputs, 3 digital outputs)				2					
Standard I/O only, NEMA 4, conformal coating				5					
Not Used						0			
Design Model									
General Purpose, FM/CSA approval							A		
European Approval (CE Certification - for European Community destinations)							B		
Programming / Special Features - see Note 2									
None								S	T
Configured to customer's MOD 30 specifications								M	3
									D
									0

ACCESSORIES

ICN Termination Assembly (1 per ICN network)	2030FZ00001A
Portable Memory Module (optional)	2010PZ10000A
Upgrade to Version 2 Identity Module	1800PZ10102C
Housing & termination assembly only (no instrument) - MOD 30 conversion	1800FZ00002A
Output Holder / Manual Loader (see S-MOD-1750N)	1750NZ10001A

Configuration software for RetroPAK Controllers and MODCELL Multiloop Processors

	VIZAPP	-	___	-	DEV	-	___	-	___
	VIZAPP								
Communications Interface									
Deluxe - ICN and XModbus OPC Servers Included <i>Includes one 109S1854 downloading cable for MOD30ML</i>			DLX						
ICN OPC Server Included			ICN						
Extended Modbus OPC Server Included <i>Includes one 109S1854 downloading cable for MOD30ML</i>			XMB						
Network (No OPC Server included)			NET						
Functionality									
Development				DEV					
Software Key Type									
Parallel Port					PAR				
USB (Universal Serial Port)					USB				
Extended Support Services (ESS)									
None								000	
One Year Technical Support & Version Updates								ESS	

I/O MODULES

	Positions	Power	
Analog Input - isolated			
Voltage (+/- 100mv, +/- 10V)	1	80mA	2001AZ10101B
Current (4-20mA)	1	80mA	2002AZ10101B
Current (4-20mA) with 2-wire transmitter power	(Note 1)	350mA	2012AZ10101B
RTD (2-wire, 1000 ohm nominal resistance)	1	80mA	2009AZ10220B
RTD (3-wire, 100 ohm nominal resistance)	2	80mA	2009AZ10130B
RTD for Cold Junction Compensation (1 per base instrument). Required if built-in input 1 is not used as tc+cjc and thermocouple inputs are used.	1	80mA	2009AZ10240B
Thermocouple (supports type B,E,J,K,N,R,S,T and calibrated)	1	80mA	2013AZ10101B
Analog Output - isolated			
Current (4-20mA / 0-20mA)	(Note 1)	350mA	2003AZ10101A
Digital Input - Isolated			
2.5 to 28V dc	1	12mA	2004AP10100A
4 to 16V dc	1	12mA	2004AP10110A
10 to 32V dc, 12 to 32V ac	1	12mA	2004AP10120A
35 to 60V ac/dc	1	12mA	2004AP10130A
90 to 140V ac/dc	1	12mA	2004AP10140A
180 to 280V ac/dc	1	12mA	2004AP10150A
Digital Output - Isolated			
5 to 60V dc	1	12mA	2005AP10100A
5 to 200V dc	1	12mA	2005AP10110A
12 to 140V ac, SPST, NO	1	12mA	2005AP10120A
24 to 280V ac, SPST, NO	1	12mA	2005AP10130A
24 to 280V ac, SPST, NC	1	12mA	2005AP10140A
Digital Input - Nonisolated			
2.2V to 24V dc (contains internal 5V supply for direct hardwire connection)	1	10mA	2006AZ10100A
Digital Output - Nonisolated			
25V, 50mA TTL (open collector switch supports 5V TTL)	1	20mA	2007AZ10100A
Mechanical Relay Output - isolated			
Dual SPST, NO/NO (2 outputs)	2	140mA	2011AZ10100A
Dual SPST, NC/NC (2 outputs)	2	140mA	2011AZ10110A
Dual SPST, NO/NC (2 outputs)	2	140mA	2011AZ10120A
Form C (1 output)	2	140mA	2011AZ10200A
Extended I/O Interface (see SS Remote-I/O for remote modules)			
Extended I/O Interface Module (one per Remote I/O Network; 2 max)	2	400mA	2020NZ10000B

Note 1: These active current modules use one position, however they require that one module space on each side be unused.

Communication Modules and Accessories on following page

COMMUNICATION MODULES AND ACCESSORIES

Communication Modules (one per instrument in addition to built-in communication channel)			
Instrument Communications Network (ICN)*	2	300mA†	2030NZ10000B
Serial Communications for Modbus RTU:			
RS-232**	2	180mA	2033NZ10000A
RS-485, 4-wire**	2	180mA	2034NZ10000A
Accessories			
ICN Termination Assembly (1 per ICN network)			2030FZ00001A
Portable Memory Module (optional)			2010PZ10000A
Output Holder / Manual Loader (see S-MOD-1750N)			1750NZ10001A

* One ICN module is required in the MOD 30 Replacement instrument if the built-in communications port is used for RS-232 through the front panel.

** Provides pull-up/pull-down resistors for Modbus network, and address switch. Required when using MOD 30ML as master.

† 2030F terminator assembly adds 200mA for total ICN module load of 500mA to controller unit on which it is installed.

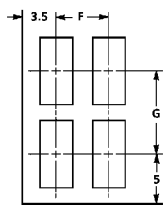
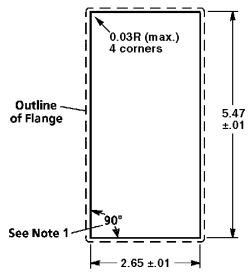

Center-to-Center Distance	F	G
Recommended	4	8
Minimum	3.5	7

PANEL CUTOUT

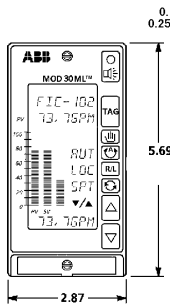

FRONT VIEW

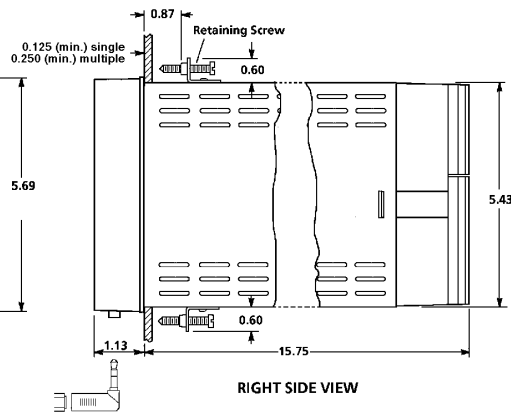

RIGHT SIDE VIEW

Inches	mm	Inches	mm
0.6	15.2	5.43	137.9
0.87	22.1	5.47	138.9
1.13	28.7	5.69	144.5
2.69	68.3	7	177.8
2.87	72.9	8	203.2
3.5	88.9	15.75	400
4	101.6		

1.5 inch (38.1mm) clearance for optional communications jack.

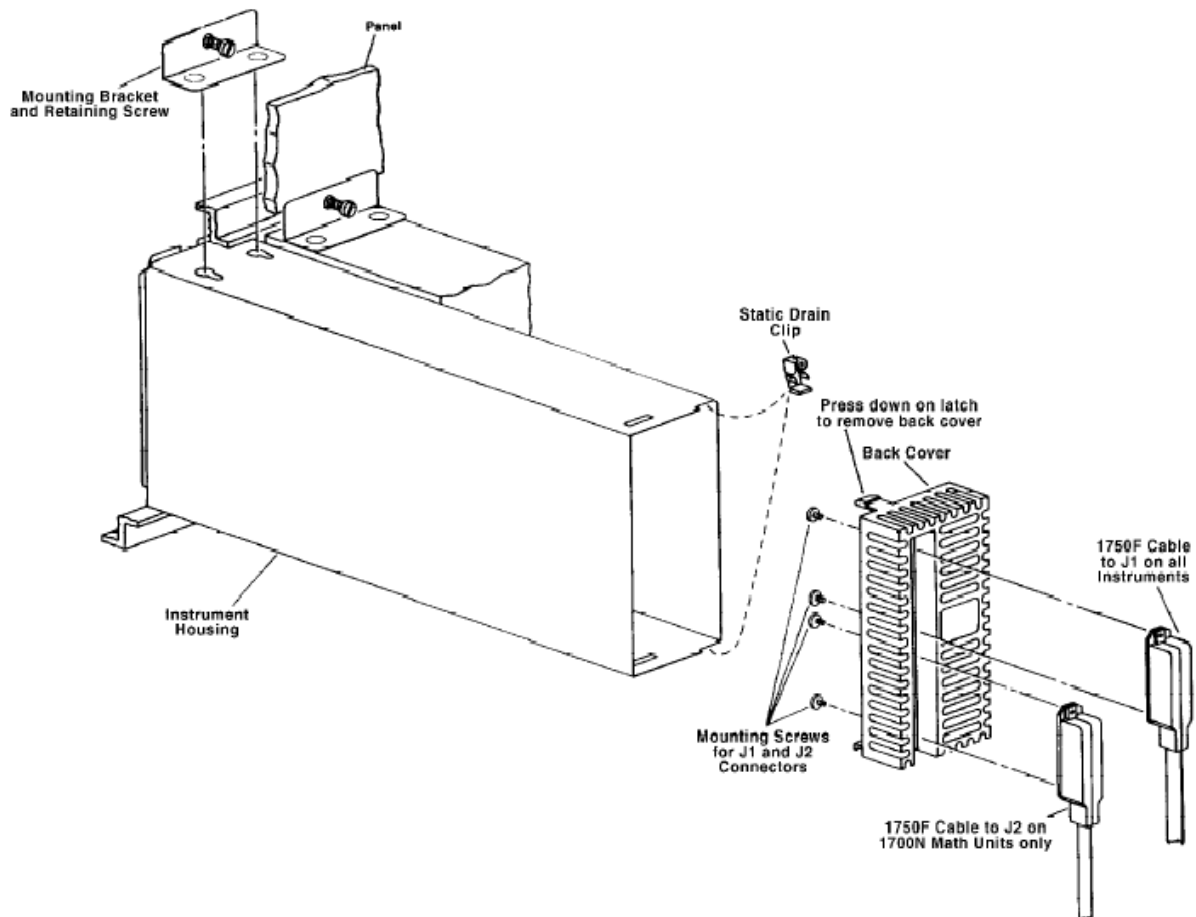

www.micromod.com

The Company's policy is one of continuous product improvement
and the right is reserved to modify the information contained
herein without notice.

Printed in USA (July 2008)

© MicroMod Automation, Inc. 2004



MicroMod Automation, Inc.
75 Town Centre Dr.
Rochester, NY 14623 USA
Tel: (585) 321-9200
Toll Free: 1-800-480-1975
Fax: (585) 321-9291
Email: sales@micromod.com