

MICRO-DCI™ Process Control Station

Series 53MC5000

- High Visibility CRT-type dot matrix operator display
- Family of configurable process graphic displays and standard Controller Templates
- One, Two or Four loops of control
- Modular design enables user selection of many expansion options both software and hardware
- Easy implementation using library of preconfigured Flexible Control Strategies (FCS)
- Configurable Control Interconnection Modules (F-CIM) for more complex applications
- F-TRAN high level programming available to solve difficult applications
- Easy-Tune™ PID self-tuning algorithm standard in all product version
- Standard Micro-DCI™ DataLink communication port (RS-422/485)
- Standard RS-232C configuration port
- Compact standard DIN case (72 x 144 mm Bezel), only 12" in length
- Optional Dual high speed (2 Mb) highway with Peer-to-Peer communication
- Optional PLC and Printer communications interface

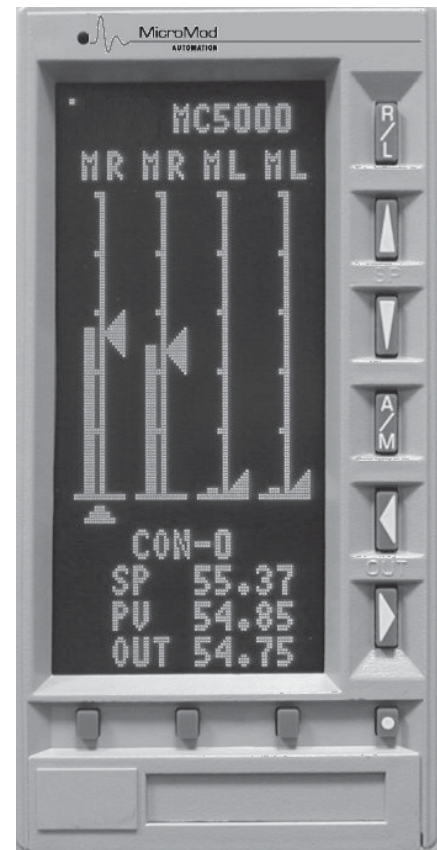

Series 53MC5000
Process Control Station

Micro-DCI™ PROCESS CONTROL STATION

The **53MC5000** is MicroMod Automation's state-of-the-art Process Control Station designed to perform any process application, from simple PID to the most complex control strategy. Its sophisticated design includes an embedded microprocessor Application Specific Integrated Circuit (ASIC) and Surface Mount Technology, providing superior performance and reliability. The **53MC5000** is the cornerstone of the Micro-DCI™ generation of modular control systems.

The **53MC5000** operator interface incorporates a high visibility dot matrix graphic display. This display supports both standard and customized screens for maximum user flexibility.

The **53MC5000** is available in One, Two, or Four-loop control versions, and is designed for expansion on multiple levels; Functionality, Hardware, and Software. This allows the user to select only the functions required for a given application. Option boards expand the controller hardware as required; discrete inputs & outputs, analog inputs & outputs, or communication ports. Software may be extended to permit the configuration method that best fits the application; the prewritten and configurable Flexible Control Strategy (FCS), configurable F-CIMs (Control Interconnection Modules), or F-TRAN, MicroMod Automation's high-level control language.

53MC5000 Overview

The **53MC5000** can handle a wide variety of control applications. At the operator interface level, this is achieved using multiple screens to provide full process variable and alarm display of all data. The high visibility dot matrix display permits many operator screens of both digital and graphical data in a single unit. The use of standard and/or customized displays enhances the operator interface to the process. A display hierarchy is included to minimize operator keystrokes. The controller is able to scan all inputs, solve PID algorithms, generate outputs and update screens in less than 100 milliseconds. At the same time, multiple self-diagnostics verify performance.

At the process Input/Output level, the **53MC5000** modular hardware provides a standard I/O mix and allows for expansion capability. Standard I/O includes four analog inputs, two analog outputs, two discrete inputs, and two discrete outputs. Option boards enable the **53MC5000** to support the following additional I/O: four analog inputs and two analog outputs; a universal input (high level, thermocouple or RTD); discrete inputs/ outputs (6 DI/4DO or 16 assorted DI/DO).

Control Strategies are implemented in the **53MC5000** using one of the following methods:

- Select a Flexible Control Strategy (FCS) configuration from a library resident in the 53MC5000
- Select and modify pre-written FCS configurations for custom applications
- F-CIM connection of standard or custom modules for special applications
- F-TRAN high level language for complex applications and/or custom displays

Control Strategy configuration can be generated or modified using any of the following methods:

- Database parameters, FCS, or F-CIM configuration through controller faceplate keys
- Database parameters or FCS configuration through the Hand-Held Configurer (HHC) ASCII keypad
- Database parameters, FCS, F-CIM, or F-TRAN configuration using the MicroTools™ configuration tool kit 53MT6000 configuration software running in a personal computer (PC)
- Database parameters, FCS, F-CIM, or F-TRAN configuration using the Micro-DCI Personnel Work Center (Micro-PWC) model 53PW6000

The **53MC5000** includes a standard Micro-DCI communication port (RS-422/485 at 28.8 Kbaud) called DataLink. DataLink allows monitoring and configuration over a network from the Micro-PWC operator station or using the Custom Program Interface software. The **53MC5000** is easily implemented in new or existing networks of Micro-DCI™ products. As an option, the controller can be equipped with a 2 Mbaud highway called MicroLink. MicroLink provides peer-to-peer communication and can be purchased in redundant configurations. The **53MC5000** and the Micro-PWC provide a total system solution to solve a broad range of application problems.

Operator Interface

The **53MC5000** Process Control Station's dot matrix display provides unequalled presentation of information to the user in a stand alone controller or in combination with an Operator/Engineer Workstation. The combination of displays and front panel keys provides a broad range of operator interaction; far beyond the capabilities of the traditional panel-mounted controller. To assist the user, a set of pre-configured displays and a display handler are provided as standard. Each display includes three general areas of information:

- The entire display screen is available to configure static data and/or dynamic points.
- The top line of the display is used as an alarm line. The "ALARM" message will be displayed when an alarm occurs regardless of the current user display.
- The bottom line of the display is used as a scratch pad area when configuring in the Engineering Mode. Single line menu options and User entered data are displayed for operator convenience.

Function Keys

The controller front panel has ten (10) functional pushbuttons (see Figure 2). The function of each of these pushbuttons is determined by the type of display currently selected and the mode of operation.

The **53MC5000** has two standard operating modes: Controller Mode (normal operating mode) and Engineering Mode (configuration mode).

The keys and their functions are described below. Unless specified as an Engineer Mode function, the functions listed are for Controller Mode.

R/L - This key is used with the Control loop displays (Point, Group, or Point Trend) to switch between REMOTE and LOCAL setpoint modes.

SP arrows - The two (2) setpoint pushbuttons are used to adjust the setpoint of control loop displays when in local and to highlight various selections in other displays. In Engineering Mode these keys are used to highlight, change or set values.

A/M - This button is used by the control loop displays to switch between AUTOMATIC and MANUAL control Mode.

OUT arrows - The two (2) output pushbuttons are used by the control loop displays to adjust the output of the controller when the controller is in manual. In Engineering Mode these keys are used to highlight, change or set values.

MODE Button - The "MODE" button is used to acknowledge an alarm or enter Engineering Mode (once alarms have been acknowledged). Pressing the MODE key while in Engineering Mode will return the user to the normal Controller Mode.

F1 - The F1 key is normally used to page through groups in the display hierarchy. In Engineering Mode, the F1 key moves the user back to the previous menu level.

F2 - The F2 key is normally used to advance to the next display within a group. In Engineering Mode, the F2 key is used to advance through the various choices (Display - Configure - Program).

F3 - The F3 key is used as a "SELECT" and "ENTER" key by the Status, Parameter, and Summary displays. In the TWO and FOUR LOOP display, it toggles between the loops. In Engineering Mode, the F3 key is used as "ENTER" to choose the current menu selection or to complete an entry.

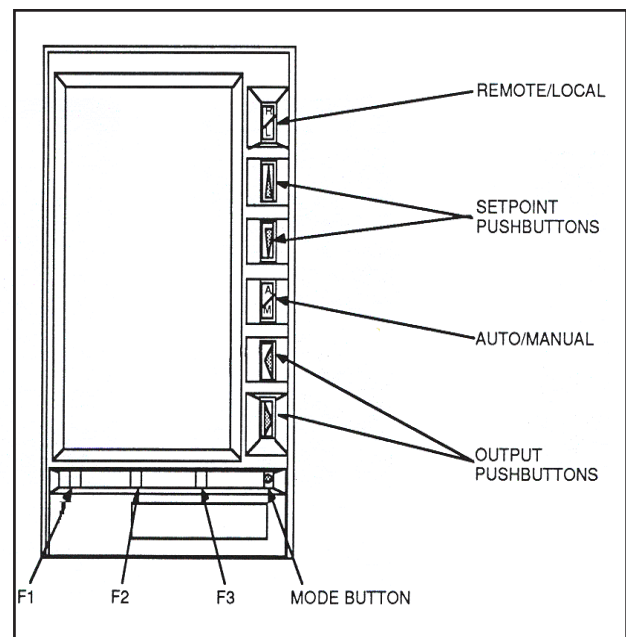

Figure 2: MC5000 Operator Keys

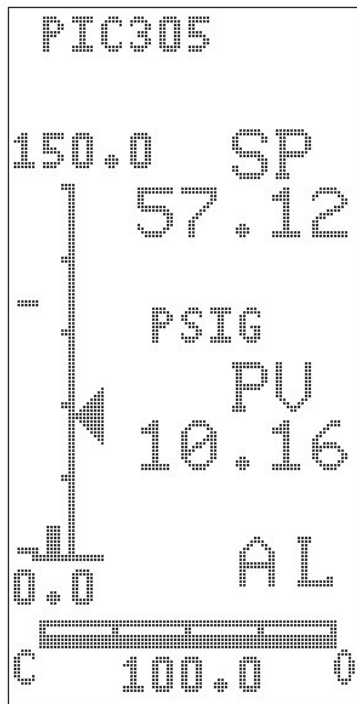

Figure 3: Single Loop

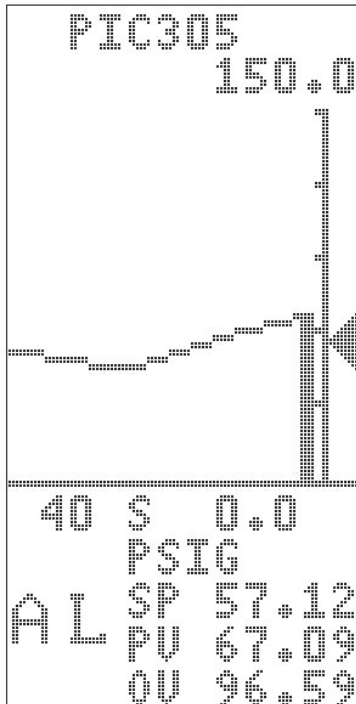

Figure 4: Single Loop with PV Trending

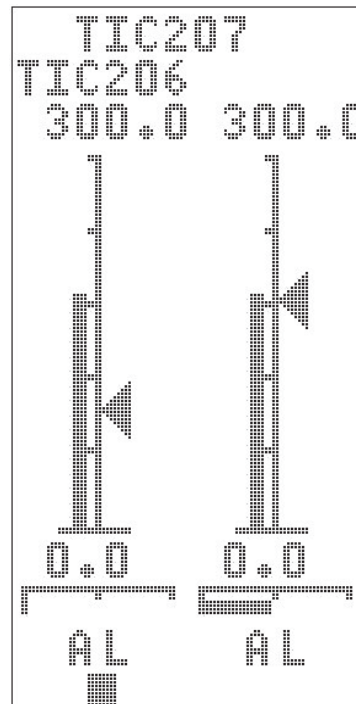

Figure 5: Two Loop

Displays

A dot matrix gas discharge display provides the operator window to the process. A family of standard preconfigured displays incorporating dynamic bargraphs, trends, and digital data are stored in the 53MC5000. These include; Single Loop, Single Loop with PV Trending, Two Loop, Four Loop, Parameter, Point Status, and System Status (diagnostic) displays. Additional custom displays of dynamic and static data can be developed by the user or MicroMod Automation for specific process application requirements. Displays are oriented in a configurable hierarchy for easy selection. The display hierarchy may be modified for any user applications. Examples of the standard displays are presented in Figures 3 through 11.

(Note: Images in the figures are captured from the Hires display.)

Single Loop - This display is available for each control loop in the controller (up to four). Each control loop's alphanumeric tagname is displayed at the top of the screen. The loop Process Variable (PV) is displayed both digitally and in bargraph form. The loop SetPoint (SP) is displayed digitally and an indicating arrow. Process alarms are also displayed as "TIC" marks to the left of the PV bargraph. When in alarm condition, the PV bargraph will flash and a text message (alarm line) will flash indicating the

type of alarm. The PV bargraph is displayed with a scale including the minimum and maximum range values. Process variable engineering units are also displayed. The control Output (OP) is represented as a horizontal bargraph and a digital value. 0% output may be either Open (O) or Closed (C) as required. Auto/Manual and Remote/Local status indications are displayed at the bottom of the screen (see Fig. 3).

Single Loop with PV Trending - This display is available for each control loop in the controller (up to four). Each control loop's alphanumeric tagname is displayed at the top of the screen. The loop Process Variable (PV) is displayed digitally (with Engineering Units), bargraph, and current trend form. The PV bargraph is displayed with a scale including the minimum and maximum range values. The setpoint (SP) is displayed digitally and as an arrow to the right of the PV scale. Alarm limits are displayed as "TIC" marks to the left of the PV bargraph when configured. When in alarm condition, the alarm line and PV bargraph flash. The output (OP) is digitally displayed. The trend displays the maximum time base in seconds or minutes. Auto/Manual and Remote/Local status indications are displayed at the bottom of the screen (see Fig. 4)

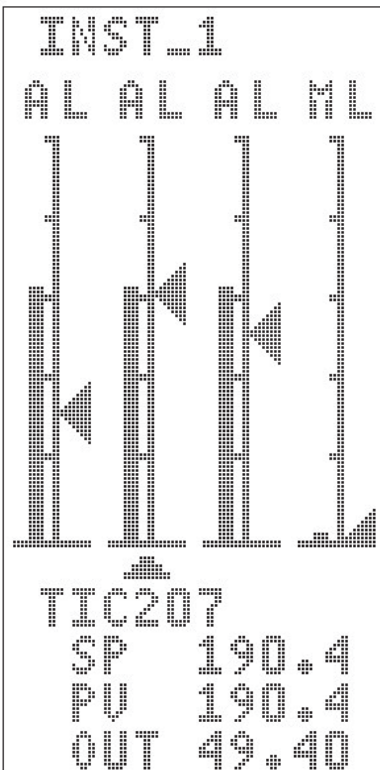

Figure 6: Four Loop Display



Figure 7: Parameter Display

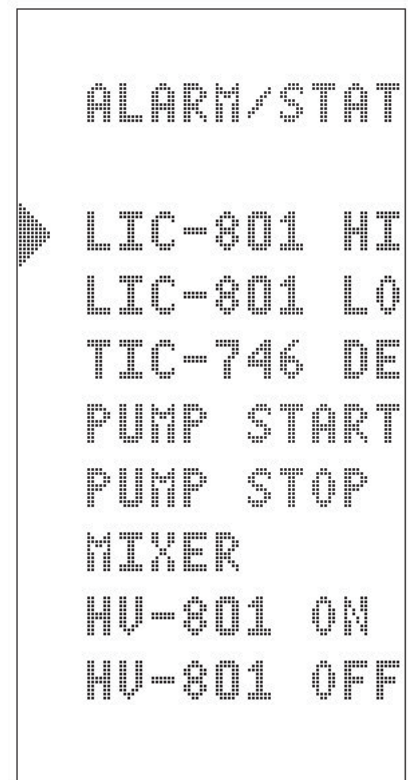

Figure 8: Alarm/Status Display

Two-Loop - This display shows two abbreviated single loop bargraph displays simultaneously. The screen displays both alphanumeric tagnames at the top of the screen, left and right justified as required. The loop PV and OP are displayed in bargraph form with a SP arrow. Control pushbuttons (R/L, A/M, and INC/DEC) are active only for the selected loop, indicated by a square cursor below the bargraph. Alarm limits, alarm displays, scales, controller mode, and the output bargraph are similar to Single Loop displays (see Fig. 5).

Four-Loop - This display shows four abbreviated single loop bargraph displays simultaneously. The screen displays the tagname of the selected loop at the bottom of the screen along with the digital values of the loop PV, OP and SP. The bargraph display includes the PV bargraph, the SP indicating arrow and controller mode (R/L,A/M). Control pushbuttons (R/L, SP increase/decrease, A/M, and output increase/decrease) are active for the selected loop only, indicated by a triangular cursor below the bargraph (see Fig. 6).

Parameter - Eight Parameter Displays are provided for user access to controller database locations normally accessible through engineering mode

(Password Protected). Parameter displays provide the display and modification of any three (3) database parameters such as alarm limits or tuning constants. Each Parameter Display module has its own user configurable alphanumeric legend displayed at the top of each screen. Each database location assigned to the parameter display also has a user configurable alphanumeric label. (see Fig. 7)

Alarm/Status Display - Two Alarm/Status displays can be configured to display alarm information, contact status information or a variety of other logical data information. Each display has a user configurable alphanumeric legend that appears at the top of the screen and alphanumeric legends for each of eight (8) status points assigned to the display. Each legend represents the value of a single logical in the controller. If the status value equals zero (0), the tagname will be displayed in standard video. If the status value equals one (1), the legend will be displayed in reverse video. Each assigned logical value may also be designated as an alarm. The legend will flash, in alternating direct/reverse video, for logical values whose alarms are enabled and the status is one (1). Status Displays allow operator input as well. This operator access allows motors and pumps to be started and stopped from the display screen, (see Fig. 8).

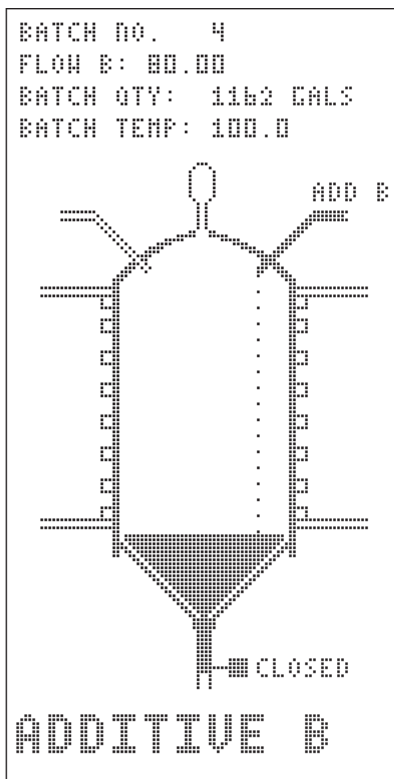

Figure 9: Custom

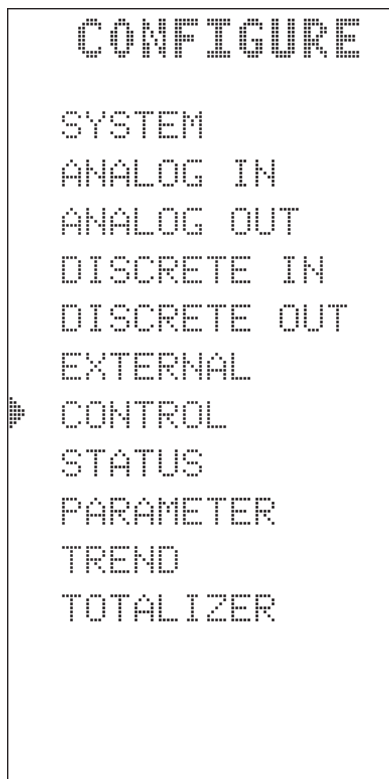

Figure 10:
 Configuration Menus

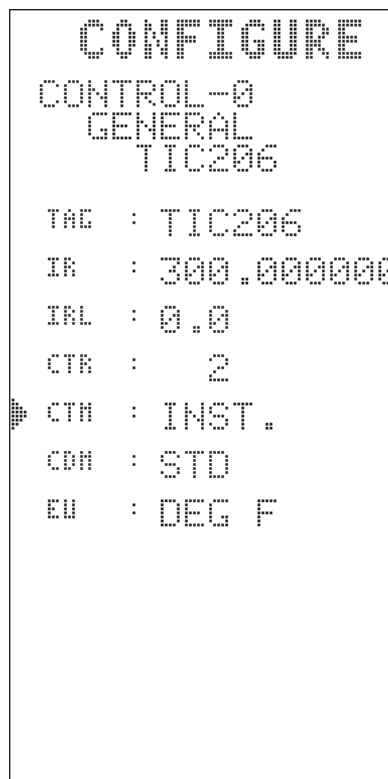

Figure 11:
 Control Loop Configuration

Custom - The controller incorporates the ability for the user to develop special displays of static and/or dynamic data presentation for his application. These displays are developed using MicroMod's Display F-TRAN statements. The statements provide the ability to print text, draw lines, draw bargraphs, and draw trends. Lines, bargraphs, and trends may be either vertical or horizontal. Bargraphs and trends use "live" data for display (an example of a custom display is shown in Fig. 9).

Configuration Menus - Figures 10 and 11 are a sample of the configuration menus supplied on the High Resolution version of the 53MC5000 controller. These configuration menus allow the user the ability to change the controller configuration without requiring a knowledge of the controllers database. A heirarchy of menus provides access to more and more configuration detail as well as fast access to specific database parameters.

Totalizer - Each 53MC5000 controller has eight (8) totalizers as a standard feature. Each totalizer can be customer configured to accept inputs from a variety of sources including the normal analog input signals or a calculated value from within the controller. Scaling parameters allow a wide range engineering units options (gallons, Kgallons, Mgallons, etc.). Each totalizer also has a user definable rollover value and the ability to soft-wire the rollover to a contact output. A momentary pulse is generated each time the totalizer rolls-over. Refer to Fig. 12.

System Status - This two page screen displays information useful for evaluating the controller hardware configuration and performance. Information on the two screens include the configured Model Number, the Control Strategy currently executing, the Control Strategy Scan rate, the controller Instrument Address, the DataLink communication baud rate and the Option card status. Also available is the system Run Time Counter (Design Level A or B) or Real Time Clock (Design Level B). Refer to Figures 13 & 14.

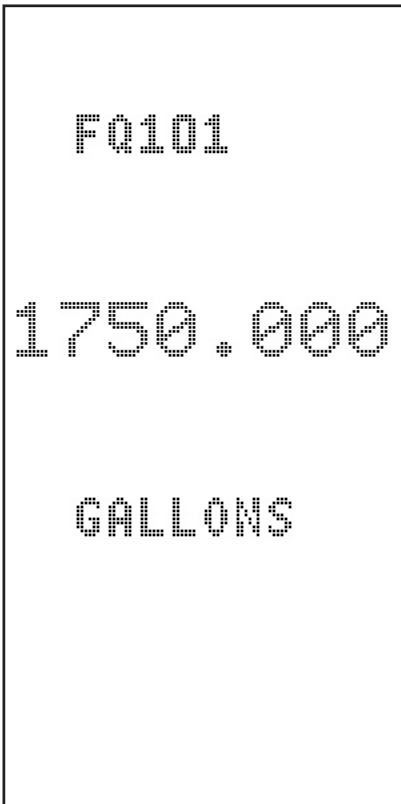

Figure 12: Totalizers

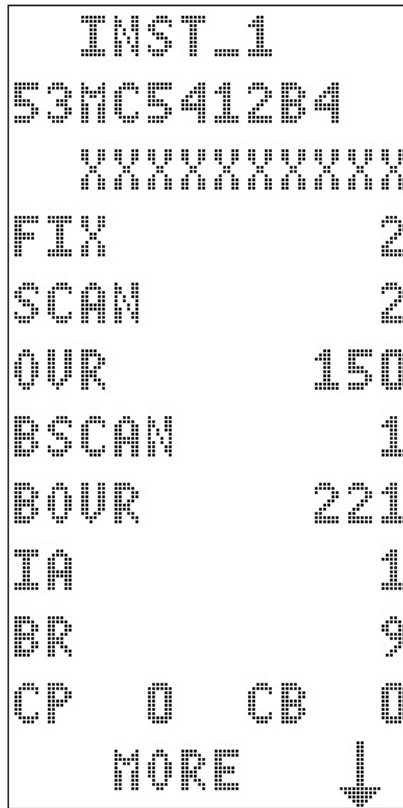

Figure 13: System Status 1

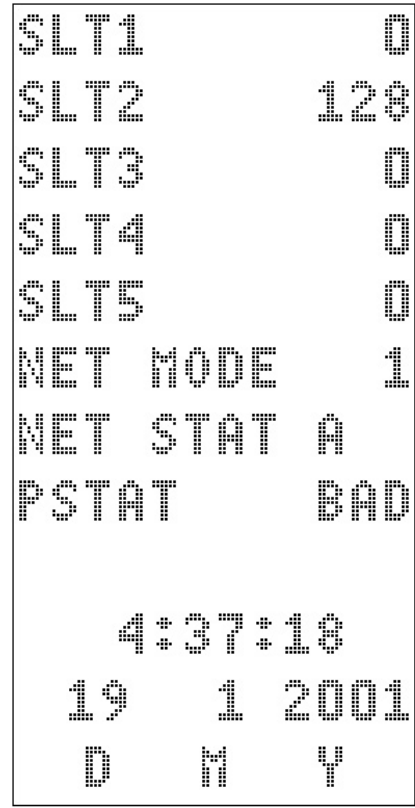

Figure 14: System Status 2

Configuration And Programming

The **53MC5000** is offered in Single-Loop (53MC5100), Two-Loop (53MC5200), and Four-Loop (53MC5400) functional models with Standard and Extended versions. The Single-Loop controller is offered only in the Standard version. The Two-Loop and Four-Loop controllers are available in both Standard and Extended versions. All models have pre-programmed control strategies stored in ROM. Control strategies allow the user the ability to implement standard control quickly and easily, without the need to invest time in configuration.

The 53MC5000 Standard version includes the Flexible Control Strategy (FCS). The user selects preconfigured control strategies stored in ROM and loads them into FCS. The Extended model allows the user to modify both the functionality of the modules, as well as the order of execution through F-CIM (Control Interconnection Modules) configuration. The user also has the ability to use “F-TRAN”, which is a high level language for the most complex applications. Configuration can be performed in the manner preferred by the user; controller data entry keys, an optional hand-held configurator, an IBM-PC or compatible using HC3300C software, or through a Supervisor-PC network.

Flexible Control Strategy (FCS)

The Flexible Control Strategy (FCS) is a sequence of control modules that can be configured to fit most process applications. A One-Loop **53MC5000** has one set of these control modules. A Two-Loop version has a second, independent set of control modules and the Four-Loop version has four sets. A library of commonly used control strategy configurations is resident in the **53MC5000**. These control strategies include standard PID, Ratio, Two-loop, Cascade, and others. The user merely inputs his specific process parameters to implement a powerful control strategy. FCS permits the pre-configured strategy to be enhanced through the implementation of standard Math, Logic, Totalization, Control, and I/O Assign modules. FCS is very easy to use, but is powerful enough to implement special requirements.

Implementing a strategy simply involves loading the set-up values from ROM to make FCS perform the desired control strategy. For most process applications, the unit can immediately be placed in service utilizing these standard strategies. If a specialized strategy is required, the user need only modify the standard strategy to implement his specific change, not develop the entire strategy. Modifications are performed by changes to the module "softwiring". Softwiring involves pointing the inputs of FCS modules at the outputs of other FCS modules. This list of pointers or "wirelist" is then stored as database parameters.

NOTE THAT NO PROGRAMMING IS REQUIRED TO IMPLEMENT A STANDARD OR MODIFIED FCS.

The following descriptions detail each of the ten (10) standard Flexible Control Strategies.

The **CS 1 - PID Controller** is utilized in conjunction with other devices to automatically control a process variable (PV) at a predetermined set point (SP). The proportional, integral and derivative (PID) terms can be activated as needed. The standard strategy may include multiple supplementary functions like; remote setpoints, additive or multiplicative feedforward, output tracking, PV retransmission, etc.

The **CS 2 - Analog Backup Controller** is used in operations where a remote computer is normally controlling the final element directly. In this arrangement, the controller acts as a control signal selector and as an automatic backup. As a backup the controller will assume control of the process in the event of an indicated computer failure.

The **CS 3 - Ratio PID Controller** is used where one variable must automatically be maintained in definite proportion to another variable. The PID algorithm is executed to maintain a "controlled line" at a predetermined proportion to the uncontrolled or "wild line".

The **CS 4 - Automatic/Manual Station** configures the controller into a conventional single station automatic-manual selector. In "Auto", the Auto Input is passed directly through the station to the output. In "Manual", the station acts as a manual loader.

The **CS - 5 Ratio Automatic/Manual Station** configures the controller into a versatile ratio station with manual loading.

The **CS 20 - Two Loop Controller** consists of two identical standard PID controllers, in effect making the unit equivalent to two individual controllers.

The **CS 21 - Two Loop Cascade Controller** consists of two standard PID control loops arranged in the usual cascade setup with a primary and related secondary controller. The output of the primary controller, based on its setpoint and process variable, becomes the setpoint for the secondary control.

The **CS 22 - Two Loop Override Controller** consists of two standard PID control loops. Override control is used where two interdependent variables are being controlled via a single element and neither variable may exceed a safe limit. Such a process requires that the variable tending to depart in the undesired direction be the loop maintaining control of the final element. To accomplish this the two control loops are arranged such that both loops holding the unselected loop near the active control output range.

The **CS 40 - Four Loop Controller** consists of four identical standard PID controllers, in effect making the unit equivalent to four individual controllers.

The **CS 41 - Dual Two Loop Cascade Controller** consists of dual sets of two standard PID control loops arranged in the usual cascade setup with a primary and related secondary controller.

Since the loops are independent in the two and four-loop versions, any combination of loop types and modes is easily configured. For example, a Four-loop controller can be configured with two standard PID loops and one two loop cascade.

F-CIM (Control Interconnection Module)

For more complex process applications, ABB has developed F-CIM configuration. F-CIM is an easy-to-use configuration technique which connects control modules in any sequence desired. It is possible to use pre-configured modules and add or modify modules to develop any control scheme. Most modules have no limit on the number of times they can be used. For special applications, custom modules can be created. This provides an almost unlimited ability to develop control strategies quickly and easily.

Standard Module Types Include:

General Modules

Read Write Display

Numerical Operations

Pre-written, selectable equations
Add, Subtract, Multiply, Divide
Square Root
Log (base 2)
X to the power Y
Absolute value

Logical Operations

AND OR XOR

Control Modules

Setpoint Generation
PV Deviation
PID algorithm
Auto/Manual Switching

F-TRAN

F-TRAN is a proprietary programming language developed by MicroMod especially for use in developing custom control strategies in Micro-DCI controllers.

The F-TRAN programming capability provides the math and logic requirements for batch and model-based advanced control.

The F-TRAN programming language is a high level scientific programming language, with programs written as a series of data statements. F-TRAN language statements operate on the Controller data base to produce numerical or logical outputs. The Controller I/O and display, for example, are a part of this data base.

The following is a summary of some of the F-TRAN programming operations:

Numerical Operations

| | |
|----------------|------------------------------|
| Addition | Subtraction |
| Multiplication | Division |
| Square Root | Compare |
| Log (base 2) | 2x |
| Yx | Swap (X \leftrightarrow Y) |
| Duplicate | Get Pulse Input Data |
| Absolute Value | Totalize |

Logical Operations

| | | |
|-----|--------|-----------|
| AND | OR | Duplicate |
| XOR | Invert | |

For program flow control, unconditional jumps and conditional skips, forward and back, are allowed. Indirect addressing, which allows the user to program advanced control schemes such as dead time compensation and mathematical model based approaches, is also supported. These features greatly enhance the utility of the F-TRAN programming language in the 53MC5000.

Prewritten subroutines, such as the PID control algorithm, are included in firmware and can be accessed from a custom F-TRAN program. These subroutines are well documented for the user. This greatly simplifies the task of creating a custom control application program.

Easy-Tune™

Easy-Tune MicroMod's self-tuning algorithm included as standard in all versions of the MC5000. This algorithm estimates the process as first order and calculates the process gain, first order time constant, and deadtime. The controller has the ability to execute the subroutine manually or automatically to precisely calculate loop tuning coefficients. Calculated coefficients can be displayed or automatically be entered into the loop.

Refer to Technical Bulletin 53MC2000-ST for a complete description of Easy-Tune.

Hardware Expansion Options

Every controller is supplied with the following standard

I/O:

- 4 Analog Inputs
- 2 Analog Outputs
- 2 Discrete Inputs
- 2 Discrete Outputs
- Standard Data Highway
- RS-232 Configuration Port

Standard analog and discrete I/O is built into the Main Board and available for use with any of the FCS, F-CIM, or F-TRAN configuration techniques. Terminations for standard I/O may be made either directly to the back of the unit or to a remote mounted Interface Terminal Board (ITB).

The modular design of the **53MC5000** permits additional I/O through use of an Expansion Board. Each Expansion Board has dedicated slots to add analog, discrete, or communication options. The following options are available via Option Boards which plug into the Expansion Board:

- 6 DI/ 4DO Option Board
or
16 DI/DO Option Board
- Single Channel Analog Option
or
Multi-Channel Analog I/O Option
- MicroLink Communication Option
Single or Redundant
- Multi-Channel Analog/HART
Communications
- Digital Device Interface HART
Communications
- Digital Device Interface PLC/Printer
Communications

The 6 DI/4 DO Option Board provides an additional 6 discrete inputs and 4 discrete outputs to the standard I/O (total of 8 DI and 6 DO). The 16 DI/DO Option board provides any combination of 16 discrete signals, inputs or outputs. The 16 DI/DO Option Board uses OPTO 22 modules allowing individual selection of the module type to match the application. The Single-Channel Analog Input Option Board provides an additional analog input through a Custom Linearization Module. Different modules types are available including; thermocouple, RTD, and voltage. The Multi-Channel Analog I/O Option Board permits an additional 4 analog inputs and 2 analog outputs as well as the Custom Linearization Module (total of 9 analog inputs and 4 analog outputs). Wiring to Option points utilizes remote-mounted ITB's. All expanded I/O is available for use with any of the FCS, F-CIM, or F-TRAN configurations.

Communications

The Standard RS-422/485 communication port provides instant communication between the **53MC5000** and a Supervisor-PC™ in a new or existing Micro-DCI network. The Supervisor-PC network provides data exchange for process control and monitoring, as well as the ability to upload and download database and programs.

MicroLink is an optional high-speed data highway board plugged into the Expansion Board described above. MicroLink permits single or redundant communications at up to two (2) megabaud data transfer rate. MicroLink utilizes Peer-to-Peer communication enabling data transfer directly between instruments for increased network efficiency and reliability. The user may identify up to twenty-four (24) remote values to be obtained over the network. Transfer is accomplished by entering the instrument address and database location of the value to be obtained, the instrument database location where the value is to be placed, and the desired sample rate.

The **SCADA Adapter** provides a way of connecting a network of Modular Controllers to a variety of data communication devices. Typically, data communication devices are required when the total highway length exceeds the RS-485 4000 foot limitation. The SCADA Adapter performs the function of converting the RS485 Datalink to RS232 for direct connection to the data communication device. The SCADA Adaptor also provides the control elements necessary for data communication modems, such as Request to Send (RTS) and Clear to Send (CTS). The SCADA Apaptor is used in conjunction with the 53SU5000 Supervisor-PC to provide a complete data acquisition and monitoring system.

The **PLC/Printer Interface** is an exceptional way to extend the input/output capacity of the 53MC5000 by providing a convenient way to import/export Programmable Logic Controller (PLC) information. The Digital Device Interfaces (DDI-A and DDI-B) each provide the capability to transfer logical bit indicators and floating point variable to or from a PLC. PLC types that the 53MC5000 can communicate with are Allen Bradley, Modbus RTU, Siemens S5, and Koyo. In Modbus RTU mode, the 53MC5000 can be configured as a Modbus master or as a slave. The 53MC5000 can also communicate with OPTO 22 digital and analog inputs and outputs. Each DDI option is also capable of sending serial output datalog information to a printer. The output can be either the resident standard format datalog program or user generated free format datalog programs.

Ordering Information

Model Number Designation

See Notes on following page for explanation of functionality and options

| Model Code | 53MC5 | 06 | 07 | 08 | 09 | 10 | 11 | 12 | 13 | 14 | 15 | 16 | 17 | 18 | 19 | 20 |
|---|-------|----|----|----|----|----|----|----|----|----|----|----|----|----|----|----|
| Process Control Station | 53MC5 | | | | | | | | | | | | | | | |
| No. of Control Loops | | | | | | | | | | | | | | | | |
| One Loop (Note 2) | | 1 | | | | | | | | | | | | | | |
| Two Loops (Note 2) | | 2 | | | | | | | | | | | | | | |
| Four Loops (Note 2) | | 4 | | | | | | | | | | | | | | |
| Power Requirements | | | | | | | | | | | | | | | | |
| AC (110/220, 220/240 Vac 50/60 Hz) | | 1 | | | | | | | | | | | | | | |
| DC (24 Vdc) | | 2 | | | | | | | | | | | | | | |
| Functional Requirements | | | | | | | | | | | | | | | | |
| Standard | | 1 | | | | | | | | | | | | | | |
| Extended Programmable <i>provides F-TRAN programming language</i> | | 2 | | | | | | | | | | | | | | |
| Design Level/Display Type | | | | | | | | | | | | | | | | |
| Standard Resolution (48x96 pixels) | | | | | A | 2 | | | | | | | | | | |
| High Resolution (96x192 pixels -SEE NOTES) | | | | | B | 4 | | | | | | | | | | |
| Main Rear Terminal Requirement | | | | | | | | | | | | | | | | |
| Standard Rear Terminal Board | | | | | | | 1 | | | | | | | | | |
| Cord Set Connector <i>(for remote termination of standard I/O - includes backplane, ITB and 5 ft. cable. For special cable lengths see Accessories)</i> | | | | | | | 5 | | | | | | | | | |
| Chassis | | | | | | | | | | | | | | | | |
| Standard <i>(supports standard I/O only)</i> | | | | | | | | A | | | | | | | | |
| Expansion Ready <i>(required for any I/O or communication options)</i> | | | | | | | | B | | | | | | | | |
| Safety Classification | | | | | | | | | | | | | | | | |
| General Purpose | | | | | | | | | A | | | | | | | |
| Factory Mutual Class 1, Division 2 Class A,B,C,D | | | | | | | | | B | | | | | | | |
| Discrete I/O Option - includes PCB, 5 ft cable and ITB | | | | | | | | | | | | | | | | |
| Not Implemented | | | | | | | | | | X | | | | | | |
| 6 DI (26V max) and 4 DO (150mA, 50V max.) - <i>no additional modules required</i> | | | | | | | | | | C | | | | | | |
| 16 DI/DO - <i>requires plug-in modules, select from Accessories</i> | | | | | | | | | | F | | | | | | |
| DDI-A Printer / PLC Interface <i>(includes PCB, RS-232/485 converter ITB & 5 ft cable)</i> | | | | | | | | | | M | | | | | | |
| Dual Relay Board (adds two SPDT, 24 Vdc powered relays with 10A, 240 Vac contacts) | | | | | | | | | | | | | | | | |
| Not Implemented | | | | | | | | | | | X | | | | | |
| One board | | | | | | | | | | | 1 | | | | | |
| Two boards | | | | | | | | | | | 2 | | | | | |
| Three boards | | | | | | | | | | | 3 | | | | | |
| Analog I/O Option (Note 7) | | | | | | | | | | | | | | | | |
| Not Implemented | | | | | | | | | | | | X | | | | |
| Single Channel <i>(requires Analog Conversion Module - see next line)</i> | | | | | | | | | | | | A | | | | |
| Multi Channel Analog I/O <i>(analog conversion module required if using universal input)</i> | | | | | | | | | | | | D | | | | |
| Analog Conversion Modules (Required for Analog I/O option - select additional modules from P-DCI-Spares) | | | | | | | | | | | | | | | | |
| Not Implemented | | | | | | | | | | | | | X | | | |
| 0-5Vdc | | | | | | | | | | | | | B | | | |
| RTD 100 Ohm, -100 to 100 C | | | | | | | | | | | | | C | | | |
| Thermocouple Type J, 0 to 760 C | | | | | | | | | | | | | D | | | |
| Communication A Option | | | | | | | | | | | | | | | | |
| Not Implemented | | | | | | | | | | | | | | | X | |
| Datalink cable and ITB <i>(connect between controllers with Cord Set terminations for standard I/O)</i> | | | | | | | | | | | | | | | C | |
| MicroLink-A - high speed host & peer-to-peer communications <i>(includes PCB, 2.5 Ft cable and ITB)</i> | | | | | | | | | | | | | | | F | |
| Communication B Option (Includes PCB, cable and ITB) | | | | | | | | | | | | | | | | |
| Not Implemented | | | | | | | | | | | | | | | | X |
| MicroLink-B Communications <i>(provides redundant MicroLink when ordered with MicroLink A.)</i> | | | | | | | | | | | | | | | | C |
| DDI-B Printer/PLC Interface <i>(includes PCB, RS-232/485 converter ITB & 5 ft cable)</i> | | | | | | | | | | | | | | | | J |
| Conformal Coating | | | | | | | | | | | | | | | | |
| Not Implemented | | | | | | | | | | | | | | | | X |
| Required | | | | | | | | | | | | | | | | A |

ACCESSORIES**Configuration Software**

MicroTools for Windows 2000 and XP/Professional - see price list P-DCI-53MT600

Mounting & Installation Hardware

| | |
|--|------------|
| Channel for wall mounting remote termination boards (4 ft. length) | 129A003U03 |
| DIN Rail Adaptor Kit | 614B958U01 |
| DIN to 3x6 Panel Mounting Adaptor | 614B762U02 |
| Panel Filler Kit | 612B403U01 |
| Horizontal Multiple Mounting Trim Collar - see Spare & Expansion Parts P-DCI-Spare | |
| Rear-of-case Tag | 388B708A11 |
| Plastic Tag (front door latch) | |
| 250-ohm Input Resistors | 161M417U05 |

Digital Input/output Modules for 16 DI/DO Option:

| Digital Input Modules | <i>Opto model:</i> | <i>MicroMod model number:</i> |
|------------------------|--------------------|-------------------------------|
| 12-32Vac / 10-32Vdc | G4IDC5 | 2004AP10120A |
| 2.5 - 28Vdc | G4IDC5D | 2004AP10100A |
| 90 - 140Vdc | G4IAC5 | 2004AP10140A |
| 180 - 280Vdc | G4IAC5A | 2004AP10150A |
| Digital Output Modules | | |
| 5 - 60Vdc | G4ODC5 | 2005AP21100A |
| 5 - 200 Vdc | G4ODC5A | 2005AP21110A |
| 12 - 140 Vac | G4OAC5 | 2005AP21120A |

*Note: Additional digital I/O modules may be purchased directly from OPTO 22.***Notes:****Functionality**

Standard Functionality provides FCS and FCIM configuration (pre-configured, modifiable control strategies and function-block configuration)

Extended Functionality provides F-TRAN high-level language programming.

Main Rear Terminals

Standard rear terminal board provides connection for standard I/O on the back of the controller.

Cord Set Connector allows remote connection of standard I/O only.

Design Level / Display

Design Level B provides High Resolution display, new front panel menu configuration system, real-time clock and hot-swap display features. The Design Level B is a licensed product; end-user name and contact information **MUST** be supplied at time of order.

Digital and Dual Relay I/O Options

6 DI / 4 DO option does not require any additional modules.

16 DI / DO option requires plug-in digital modules

Dual Relay option may also be used with 6 DI / 4 DO or Standard Digital I/O as interposing relays

Analog I/O Options

Single Channel Analog option provides one additional universal input. Input type is determined by selection of Analog Conditioning Module.

Multi-Channel Analog option provides four additional analog inputs, two additional analog outputs, and one universal input. Input type is determined by selection of Analog Conditioning Module.

Additional Analog Conditioning Modules are available for other input types. Refer to Price Sheet P-DCI-Spares for full listing

Special Cable Lengths

All I/O and communication options are supplied with the option board (PCB), standard cable and ITB (termination board). If non-standard cable length is required, select "Not Implemented" (X) in model number and specify PCB, cable and ITB separately from Spare and Expansion Parts List P-DCI-53MC5000-Spare

Factory Configuration

MicroMod Automation can provide custom configuration services. Contact Customer Service for quotation.

More complex strategies can be implemented using F-CIM or F-TRAN in an Extended Level 53MC5000

Engineering Specifications

OPERATING CHARACTERISTICS

Power Requirements:

21 to 28 VDC
120 VAC +/- 10%, 50/60 Hz
220/240 VAC +/- 10%, 50/60 Hz

Power Consumption:

AC Operation: 36 W max

Internal Power Supply

Available Power Output for Transmitters:

24-26V dc, 80 mA, short circuit protected

Output Ripple: 200 mV p-p maximum

ENVIRONMENTAL CHARACTERISTICS

(Enclosed temperature controlled locations (class A and B per ISA S71.01 1985)

Ambient Temperature Limits: 4 to 52°C (+40 to 125°F) for single mount; 4 to 40°C (+40 to 103°F) for high density installations (For high density installations - consult Factory)

Relative Humidity Limits: 10 to 90% maximum

Temp. Effect on Accuracy: +/-0.28% per 28° (50°F) from reference temp. of 25°C (77°F)

Enclosure Classification: NEMA type 1/IEC 529 Type IP20

PHYSICAL CHARACTERISTICS

Materials of Construction

Case: Steel

Finish: RAL 9002, Light Gray

Circuit Boards: Glass epoxy

Bezel: ULTEM 1000 (Polyetherimide Resin)
Flamability-UL94 5V

Dimensions: DIN case only

2 27/32"W x 5 21/32"H x 12 26/32"L
(72 mm W x 144 mm H x 305 mm L)

Mounting: Flush panel (1/8" to 1" Thickness)

Panel Cutout: 2 11/16"W x 5 7/16"H
(68 mm W x 138 mm H)

Weight: 5 lbs. (approximate)

Electrical Connections

Rear of case compression-type terminal strips.

Front Panel

Display: 96 x 48pixel (dot addressable)

Push-buttons: 10 (membrane type switches)

INPUT SIGNALS

Analog Inputs

(All analog inputs are referenced to signal common.)

Quantity: 4 Standard (Additional optional - See Single Channel or Multi-Channel Analog Option Board)

Resolution: 12 bit

Signal Range: 0-5 or 1-5 V linear or square root
Low level input (optional): RTD or thermocouple signal.

Input Impedance: 1 megohm minimum for voltage inputs; value of ranging resistor for current signals.

Measurement Accuracy: +/-0.1% of span

Note: The standard rear terminal board has the appropriate resistors on ANI0 and ANI1. If the input signal is voltage, the resistors should be removed.

Contact Inputs

Quantity: 2 (Additional optional - See 6DI/4DO Option Board or 16 DI/DO)

Type: Discrete inputs internally powered with 4 volts @ 2 mA dc maximum (contact inputs are referenced to power common.)

Permissible Contact Resistance: 100 ohm maximum
Open/Close Contact Duration:

for open recognition: 0.05 s minimum

for close recognition: 0.05 s minimum

(Voltage inputs and CCI are sampled every 0.05 seconds)

Contact Recognition Level

Closed: 1 V dc max or less than 100 ohms

Open: 4 V dc to 15 v dc or 10 mA max

OUTPUT SIGNALS**Analog Outputs**

(All analog output signals are referenced to power common.)

Quantity: 2 Standard (Additional optional - See Multi-Channel Analog Option Board)

Signal Range: 0 - 21.84 mA dc (4 - 20 mA dc typically)

Load Resistance: 0-750 ohms

Accuracy: +/- 0.2% of span

(Current output is refreshed every 0.05 seconds. Output is updated every 0.15 seconds in a standard control strategy or at selected 0.05 second intervals in user specified control strategies.)

Discrete Outputs

Quantity: 2 (Additional optional - See 6DI/4DO Option Board or 16 DI/DO)

Type: Unpowered discrete solid state output.

Configuration: Single pole single throw, N.O., or N.C. referenced to power common.

Voltage: 30 V dc max.

Current: 50 mA dc max.

MICROPROCESSOR SAMPLING & UPDATE

Program scan rate: selectable from 0.05 to 1.5 second

Input Signal Sampling Rate

Analog: 0.05 s for all inputs

Contact: 0.05 s for all inputs

Display Update: Configurable, every 1 to 15 Program Scans

Output Signal Update: same as Program Scan Rate

CONTROL RANGES

Proportional Band: 2 to 1000%, and "off"

Integral: 0.02 to 200 minimum, or Manual Reset from 0 to 100%

Derivative: 0.01 to 8 minimum and "off"

COMMUNICATIONS**Standard Micro-DCI Data link**

Type: RS-485/422, four wire, asynchronous

Speed: Selectable - all standard baud rates between 300 and 9600; plus 14,400 and 28,800

Mode: Binary

Optional MicroLink Communication

Type: RS-485/422, four wire, CSMA/CD, peer-to-peer

Speed: Selectable - up to 2 Megabit/sec.

Mode: Binary

Optional HART® Communication**General**

Baud Rate: 1200 (fixed)

Point-to-point

Type: Frequency Shift Keyed signal superimposed on the 4-20 mA analog signal

Channel connections: 8 point-to-point

Multidrop Network

Type: RS485 to Frequency Shift Keyed digital signal

Channel connections: 30 HART™ Instruments (15 per Digital Device Interface)

Optional PLC/Printer Communication

Type: Converts RS-485/422, four wire, to RS232

Communication Baud Rate: 600, 1200, 2400, 4800, 9600, 19.2k, 28.8k, 38.4k

Communication Parity: Even, Odd or None

Set-Up: 8 bits, 1 stop

PLC Protocols: Allen-Bradley™ DF-1, OPTO 22 Serial I/O communications, Modbus Remote Terminal Unit, and Siemens 3964

Printer Protocol: RS-485/422 serial data, to RS-232

Optional SCADA Adapter Communication

Type: Converts RS-485/422, four wire, to RS-232

Modem Baud Rate: 600, 1200, 2400, 4800, 9600, 19.2k, 28.8k, 38.4k

Modem Parity: Even or None

Modem Delay: 10, 20, 30, 40, 50, 100, 200, and 250 milliseconds

Data Link Baud Rate: 9600 or 28.8k

6 DI/4 DO OPTION BOARD**Contact Input Specifications**

Quantity: 6

Operational Type: Optically coupled Phototransistors

Input Connections

Voltage Input mode: 2 term. (+ and -) each input

Contact Input mode: 2 terminals for each input (one is common)

Recognition level

Voltage Input mode: Energized - 12 to 26 Vdc range, 50 ohm max. resistance, non energized- 1Vdc maximum

Contact Input mode: Energized - 500 ohms max., 22 to 26 Vdc range. Non-energized - 60k ohms minimum 26 Vdc max.

Recognition time: 50 milliseconds

Maximum Input Voltage: 26 Vdc

Common Mode Limit: 50 V with respect to chassis ground

Transient Rejection: Meets IEEE Std. 472-1974 for Surge Withstand Capability

Recognition level

Voltage Input mode: Energized - 12 to 26 Vdc range, 50 ohm max. resistance, non energized- 1Vdc maximum

Contact Input mode: Energized - 500 ohms max., 22 to 26 Vdc range. Non-energized - 60k ohms minimum 26 Vdc max.

Recognition time: 50 milliseconds

Maximum Input Voltage: 26 Vdc

Common Mode Limit: 50 V with respect to chassis ground

Transient Rejection: Meets IEEE Std. 472-1974 for Surge Withstand Capability

Contact Output Specifications

Quantity: 4

Operational Type: Form A, SPST, normally open, optically isolated MOSFET switch

ON Resistance: 15 ohms maximum

Load Voltage Limit: 50 Vdc or peak AC

Load Current: 150 mA

Off State Leakage Current: 1 mA maximum

Common Mode Limit: 50 V with respect to chassis ground

Contact Protection: 250 mA Fuse

Transient Rejection (ITB): Meets IEEE Std. 472-1974 for Surge Withstand Capability

CCO Relay ITB Specifications

Number of Outputs: 2

Operational Type: SPDT

External Power Requirement: +24 Vdc, 200mA

Contact Rating: 10 Amp Resistive, 1 Amp Inductive, 250 Vac Maximum

16 DI/DO OPTION BOARD**Contact Input/Output Specifications**

Quantity: 16

Operational Type: Opto 22 modules

External Power Requirements: +5 Vdc, 224 mA
+24 Vdc, 420 mA

16 DI/DO ITB Specifications

See Table 2 for a listing of applicable module types.

SINGLE CHANNEL ANALOG OPTION BOARD**Analog Inputs**

Quantity: 1; Isolated

Resolution: 12 bits

Signal Range: Universal input; high-level, RTD or thermocouple signal (See Table 1).

Measurement Accuracy: +/-0.1% Full Scale

Note: The optional rear terminal board provides terminal connections (TB3) for the Single Channel Analog Option universal input (ANI 8).

MULTI-CHANNEL ANALOG OPTION BOARD**Analog Inputs****Non-Isolated**

Quantity: 4

Resolution: 12 bits

Signal Type:

Current

Signal Range: 0 - 21.84 mA

Measurement Accuracy ± 0.2 % of span

Frequency

Signal Range: 9 - 25,000 Hz

Input Impedance: 47 k Ω in series with a 0.22 MFD capacitor

Measurement Accuracy: ± 0.2 % of span

Signal Amplitude: 4 - 25 V p-p

Pulse Width: 20 microseconds min

Isolated (Optional)

Quantity: 1

Resolution: 12 bits

Signal Range: Universal input (optional); high-level, RTD or thermocouple signal (See Table 1)

Table 1: Isolation Modules Specifications

| Isolation Module | 5B30 Group | 5B31 Group | 5B32 Group | 5B34 Group | 5B47 Group |
|-----------------------------|-------------------|-------------------|-------------------|-------------------|-------------------|
| Signal Type | mV | Voltage | Current | RTD | Thermocouple |
| Accuracy | ± 0.05% span | ± 0.05% span | ± 0.05% span | ± 0.05% span | ----- |
| Nonlinearity | ± 0.02% span | ± 0.02% span | ± 0.02% span | ± 0.05% span | - 25 nA |
| Stability vs Ambient | | | | | |
| Temperature | | | | | |
| Input Offset | ± 1 µV/°C | ± 20 µV/°C | ----- | ± 0.02°C/°C | ± 1 µV/°C |
| Gain | ± 25 ppm /°C | ± 50 ppm /°C | ----- | ± 50 ppm /°C | ± 25 ppm /°C |
| Input Bias Current | ± 3 nA | ± 0.2 n | ----- | ± 3 nA | - 25 nA |
| Input Resistance | | | | | |
| Normal | 5 M ohms | 650 k ohms | ----- | 5 M ohms | 5 M ohms |
| Power Off | 40 k ohms | 650 k ohms | ----- | 40 k ohms | 40 k ohms |
| Input Protection | | | | | |
| Continuous | 240 V rms max | 240 V rms max | 240 V rms max | 240 V rms max | 240 V rms max |
| Transient | IEEE-STD 472 | IEEE-STD 472 | IEEE-STD 472 | ----- | ----- |

Signal Range: Universal input (optional); high-level, RTD or thermocouple signal (See Table 1)

Measurement Accuracy: +/-0.1% Full Scale

Input Impedance: 1 megohm minimum for voltage inputs; value of ranging resistor for current signals.

Measurement Accuracy: +/-0.1% Full Scale

Analog Outputs

(All analog output signals are referenced to power common.)

Quantity: 2

Signal Range: 0 - 21.84 mA dc

Load Resistance: 0-640 ohms

Accuracy: +/- 0.2% of span

Note : The standard rear terminal board has the appropriate resistors on ANI0 and ANI1. If the input signal is voltage, the resistors should be removed.

Table 2: OPTO 22 Module SpecificationsAC Input Modules:

| <u>OPTO 22 Part Number</u> | <u>ITB Board Voltage</u> | <u>Input Voltage Range</u> | <u>Input Current @ Max VIN</u> | <u>Input Maximum for No Output</u> |
|--------------------------------|------------------------------|--------------------------------|------------------------------------|--|
| G4DC5 | 5 Vdc | 12 - 32 Vac | 25 mA | 3 Vac |
| G4IDC5G | 5 Vdc | 35 - 60 Vac | 25 mA | 9 Vac |
| G4IAC5 | 5 Vdc | 90 - 140 Vac | 11 mA | 45 Vac |
| G4IAC5A | 5 Vdc | 180 - 280 Vac | 6.5 mA | 80 Vac |
| G4IDC24 | 24 Vdc | 12 - 32 Vac | 25 mA | 3 Vac |
| G4IAC24 | 24 Vdc | 90 - 140 Vac | 11 mA | 45 Vac |

AC Output Modules:

| <u>OPTO 22 Part Number</u> | <u>ITB Board Voltage</u> | <u>Output Line Voltage Range</u> | <u>Load Current @ 45° C</u> | <u>Load Current @ 70° C</u> | <u>Maximum Off-State Leakage @ 120 Vac</u> |
|--------------------------------|------------------------------|--------------------------------------|---------------------------------|---------------------------------|--|
| G4OAC5 | 5 Vdc | 12 - 14- Vac | 3 Amps | 2 Amps | 5 mA ac |
| G4OAC5A | 5 Vdc | 24 - 280 Vac | 3 Amps | 2 Amps | 2.5 mA ac |
| G4OAC5A5(NC) | 5 Vdc | 24 - 280 Vac | 3 Amps | 2 Amps | 2.5 mA ac |
| G4OAC24 | 24 Vdc | 12 - 140 Vac | 3 Amps | 2 Amps | 5 mA ac |
| G4OAC24A | 24 Vdc | 24 - 280 Vac | 3 Amps | 2 Amps | 2.5 mA ac |

DC Input Modules:

| <u>OPTO 22 Part Number</u> | <u>ITB Board Voltage</u> | <u>Input Voltage Range</u> | <u>Input Current @ Max VIN</u> | <u>Input Maximum for No Output</u> |
|--------------------------------|------------------------------|--------------------------------|------------------------------------|--|
| G4IC5 | 5 Vdc | 10 - 32 Vdc | 25 mA | 3 Vdc |
| G4IDC5B | 5 Vdc | 4 - 16 Vdc | 45 mA | 1 Vdc |
| G4IDC5D | 5 Vdc | 2.5 - 28 Vdc | 30 mA | 1 Vdc |
| G4IDC5G | 5 Vdc | 35 - 60 Vdc | 6 mA | 9 Vdc |
| G4IAC5 | 5 Vdc | 90 - 140 Vdc | 11 mA | 45 Vdc |
| G4IAC5A | 5 Vdc | 180 - 280 Vdc | 6.5 mA | 80 Vdc |
| G4IDC24 | 24 Vdc | 10 - 32 Vdc | 25 mA | 3 Vdc |
| G4IAC24 | 24 Vdc | 90 - 140 Vdc | 11 mA | 45 Vdc |

DC Output Modules:

| <u>OPTO 22 Part Number</u> | <u>ITB Board Voltage</u> | <u>Output Line Voltage Range</u> | <u>Load Current @ 45° C</u> | <u>Load Current @ 70° C</u> | <u>Maximum Off-State Leakage @ 120 Vac</u> |
|--------------------------------|------------------------------|--------------------------------------|---------------------------------|---------------------------------|--|
| G4ODC5 | 5 Vdc | 5 - 60 Vdc | 3 Amps | 2 Amps | 1 mA |
| G4ODC5A | 5 Vdc | 5 - 200 Vdc | 1 Amps | 0.55 Amps | 2 mA |
| G4ODC24 | 24 Vdc | 5 - 60 Vdc | 3 Amps | 2 Amps | 1 mA |

Notes: All OPTO 22 modules offer the following features:

- | | |
|---|--|
| 1) 4000 Vac optical isolation | 5) UL recognized |
| 2) Built-in LED Status Indicator | 6) CSA certified |
| 3) Removable Fuse - Output Modules Only | 7) Meets IEEE Surge Withstand specifications |
| 4) Will withstand one cycle surge of 80 amperes | |

Additional Information

In addition to this Specification, the 53MC5000 Process Control Station is supported by:

- Quick Start Installation Guide
 - Installation
 - Functionality
 - Flexible Control Strategy
- Instruction Bulletin
 - Installation
 - Operation
 - Functionality and Displays
 - Communications
 - Maintenance
- Customization Guide
 - F-TRAN (B-F&P Translator Language)
 - F-CIM (B-F&P Control Interconnection Modules)
- MicroLink™ Instruction Bulletin
 - Installation
 - Network Management
 - Gateway Functions
- 53MC5000 HART® Interface Instruction Bulletin
 - Installation
 - Operator Displays
- PLC and Printer Interfaces Instruction Bulletin
 - Installation
 - Allen-Bradley Mode
 - OPTO 22 Mode
 - Modbus RTU Mode
 - Siemens S5 Mode
 - Koyo Mode
 - Printer Interface
- Custom Program Interface Instruction Bulletin
 - 53HC3300 Rev. D
 - MC5FIG
 - MC5DRAW
 - Documentor

Micro-PWC™ Operators Console

- Micro-PWC™ Installation and Setup Guide
 - Hardware requirements
 - Installation
 - Start-up and Operation
- Micro-PWC™ Operator's Manual
 - System Features
 - Logs
 - Trend Displays
 - Graphics
 - Process Alarms
- Micro-PWC™ Configuration Guide
 - System Configuration
 - Hierarchical Displays
 - Configuration of Graphics
 - Historical Database
 - Logs
 - Trending
 - System Status Display
 - Utilities
 - Historical Block Data Collection
 - @aGlance/IT Server Interface
- MicroTools™ Configuration Tool Kit
 - 53MC5000 Configuration/Programming
 - On-line / off-line database editor
 - Project Manager

WWW.TERMOPROCESOS.COM

The Company's policy is one of continuous product improvement and the right is reserved to modify the information contained herein without notice.

Printed in USA

© MicroMod Automation, Inc. 2004



TermoProcesos e Instrumentación, SA. de CV.
 Filósofos 301-101A Col. Tecnológico
 Monterrey, NL. México ventas@termoprocessos.com
www.termoprocessos.com tpisysmx@intercable.net
 52 (81) 83 59 61 30 - 52 (81) 83 59 62 29 - Fax 52 (81) 83 58 37 77